



Connection of Timber Members

Ivan Kuznetsov and Linur Gimranov

EasyChair preprints are intended for rapid dissemination of research results and are integrated with the rest of EasyChair.

April 29, 2020

Connection of timber members

I.L. Kuznetsov⁰⁰⁰⁰⁻⁰⁰⁰¹⁻⁶⁸³⁸⁻⁰³¹⁹ and L.R. Gimranov⁰⁰⁰⁰⁻⁰⁰⁰³⁻¹⁷²⁸⁻¹⁸²⁵

Kazan State University of Architecture and Engineering, 1 Zelenaya street, Kazan,
420043, Russian Federation

leenur@mail.ru

Abstract. Expanding applicability of timber structures, especially from engineered wood is a task of utmost importance due to wood's replenishment properties as a material. This paper review new modification of mentioned above connections in lattice timber structures. This connection is comprised of timber members with longitudinal slot in combination with lateral round holes and steel plate with laterally welded-in rods which is inserted into the slot from the side of the timber member in direction of the holes axis. The distance between holes is equal the distance between welded-in rods. Weld-in rods essentially work as dowels providing mandatory installation of tightening bolts laterally to the plane in which steel plate is located. The bolt holes in the plate can be larger or equal to the bolt diameter. This research primarily focused on the development of calculation methods for the described connection validated by finite element models analysis and experimental data.

Keywords: Connections of timber structures, wood, dowels,

1. Introduction

The role of timber structures in reduction of emission footprint of building industry is shown in several studies [1], [2], [3] Structural steel as a recycled material also belongs to the category of sustainable materials. Timber as a structural material, especially in its revived form as engineering wood, gains more traction in the field of sustainable building structures. Each building material has its own advantages and disadvantages in terms of its applicability and set of restrictions in structural shapes it can be utilized for. One of the restrictions regarding to the timber structures is a required special designing approach to connections of structural members made of it.[4], Load transfer, in most cases of joints between structural members for the structures assembled on the construction site, is provided by bolt or dowel connections.[5], [9] Widening field of applicability of timber structures and increased cross-section areas of structural members made of engineering wood require larger amount of load to be transferred through joints thus new paths and design solutions of the joints between structural members are being developed.[6],[8] The designing and development stages of high load timber joints are very cost intensive tasks with results having very narrow scope of possible applicability beyond certain structural

shape or types of structures. Finite element models analysis (FEMA) validated by small scale experiments can contribute to the lowering cost of designing and developments stages. Therefore FEMA coupled with experiment were utilized as main tools in conducting this study as did others in studies [7], [19].

2. Methods

2.1. Object of research.

The subject of this study is a steel-timber joint of composite type where load transfer is provided by rods welded in steel plate, which essentially, utilized as dowels Fig.1. Composite structure of the connection is explained by the fact that some parts of a cross-section in connection are subjected to shear, whereas others are transferring compressing force. The functionality of this joint also depends on tightening bolts which also optionally can participate in load transfer. This design solution of the joint can be used primarily in lattice timber structures such us trusses, spatial roof systems, and brace members of the frames of multi storey buildings. [16]. Therefore main load was presented as tension force applied to the steel slotted plate in direction longitudinal to the grain.



a) Overall view of a connection

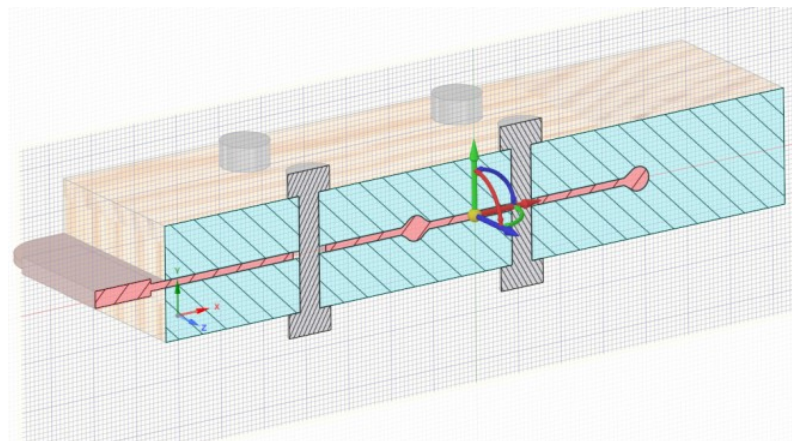

b) Longitudinal section of a joint

Fig.1 Timber-steel slotted joint.

In the Fig.1 a) an ending of structural member prepared with centrally located slot for accommodation of steel plate with weld-in rods is shown. Tightening bolts go through structural member in direction normal to the steel plate whereas weld-in rods are located in its plane (Fig.1 b).

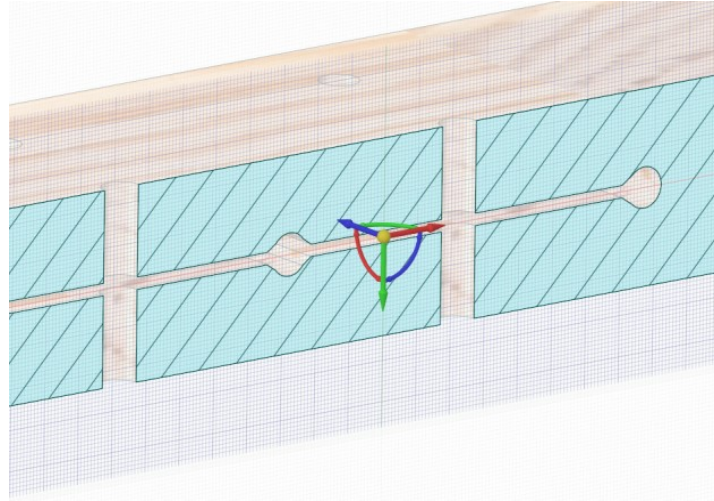

a) Preparation of the ending of a timber member

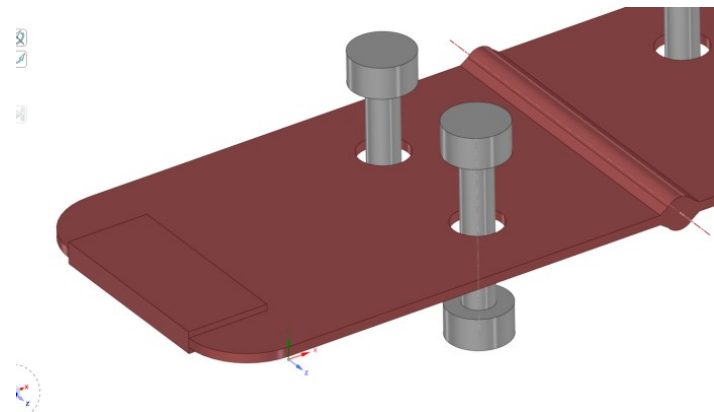

b) Steel plate with weld-in rods and tightening bolts

Fig.2 Timber-steel slotted in details.

The difference between diameter of tightening bolts and holes diameter can be seen on Fig. 2 b). This was done on purpose to examine effects of weld-in rods working as dowels. Ends of timber structural members need to be prepared as shown on Fig.2 a). Novelty of this connection, in distinction from usual dowel type connections [9-11] is determined by slotted steel plate with weld-in rods splitting holes in timber member, thus known calculation methods [12], [14] cannot be directly used for assessment of its load bearing capacity. Most alike types of connections are described in [21].

2.2. Numerical studies

FEM is a known and widely acclaimed tool for designing timber connections [13],[15],[20] This study was conducted with the help of Ansys Mechanical. In order to effectively assess all relevant factors influencing load bearing capacity of timber connection this study has focused on following components:

- Stress-strain state of timber part of connection;
- Diameter of weld-in rods;
- Amount of force transferred through weld-in rods and tightening bolts working as shear dowels respectively in combined version of connection;
- Diameter of tightening bolts working as shear dowels;
- Pretension in tightening bolts working as tightening components only;

In overall, 10 finite element models (FEM) of timber connection were explored. All analyses were executed in non-linear settings. Nonlinear analysis consisted of orthotropic and nonlinear behavior of material and nonlinear contacts. Yield strength of a timber was set at 25MPa and yield strength of a steel plate at 350MPa

Table 1. Model variations analyzed during FEM in ANSYS Mechanical

Model number	Description of factors involved in each model
1.	Model includes slotted 3mm thick steel plate with weld-in rods working as dowels with diameter 10mm. Diameter of all 4 tightening bolts is 10mm , diameter of all 4 holes in the steel plate is 16mm.
2.	Model includes slotted 3mm thick steel plate with weld-in rods working as dowels with diameter 10mm. Diameter of 2 tightening bolts is 10mm and 2 others -16mm , diameter of all 4 holes in the steel plate 16mm
3.	Model includes slotted 3mm thick steel plate with weld-in rods working as dowels with diameter 12mm. Diameter of all 4 tightening bolts is 10mm , diameter of all 4 holes in the steel plate is 16mm.
4.	Model includes slotted 3mm thick steel plate with weld-in rods working as dowels with diameter 10mm. Diameter of all 4 tightening bolts is 10mm , diameter of all 4 holes in the steel plate is 16mm. 5 kN pretension is applied to each tightening bolt.
5.	Model includes 3mm thick slotted steel plate with weld-in rods working as dowels with diameter 10mm. Diameter of all 4 tightening

-
- bolts is 12mm, diameter of all 4 holes in the steel plate 12mm
6. Model includes slotted 3mm thick steel plate with weld-in rods working as dowels with diameter 10mm. Diameter of 2 tightening bolts is 10mm and 2 others 12MM, diameter of 2 holes in the steel plate is 12mm and 2 others -16mm
 7. Model includes slotted steel plate 3mm thick and 4 bolts with diameter 12mm installed in holes with diameter 12mm
 8. Model includes slotted 3mm thick steel plate with weld-in rods working as dowels with diameter 16mm. Diameter of all 4 tightening bolts is 10mm , diameter of all 4 holes in the steel plate is 16mm.
 9. Model includes slotted 3mm thick steel plate with weld-in rods working as dowels with diameter 16mm. Diameter of 2 tightening bolts is 10mm and 2 others -16MM , diameter of all 4 holes in the steel plate is 16mm.
 10. Model includes slotted 3mm thick steel plate with weld-in rods working as dowels with diameter 10mm. Diameter of all 4 tightening bolts is 10mm , diameter of all 4 holes in the steel plate is 16mm. 8 kN pretension is applied to each tightening bolt.
-

Due to multiple different variables influencing load bearing capacity of a connection some priorities were assumed for them. Aside from load bearing capacity of the steel slotted plate weakened by holes main focus was directed at overall compressed bearing area of holes for tightening bolts and overall compressed bearing area of notches for weld-in rods described as A_{rc} and A_b .

2.3. Experiments

Tests were developed to validate theoretically obtained values of load bearing capacity of the studied connection. Test specimen was consisted of 2 slotted steel plates with weld-in rods and timber member with prepared ends. The length of timbers piece was approximately 600MM.

In overall 2 variations of connection were tested related to model 8 and model 9 described in **Table 1**. All timber specimens were selected to exclude imperfections as knots and fissures. Connections before assembly is shown in Fig.3

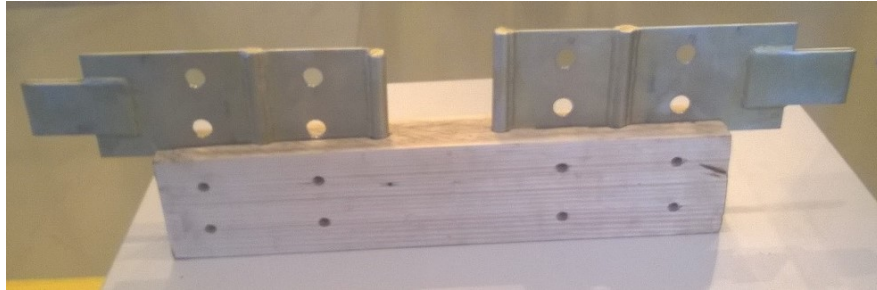
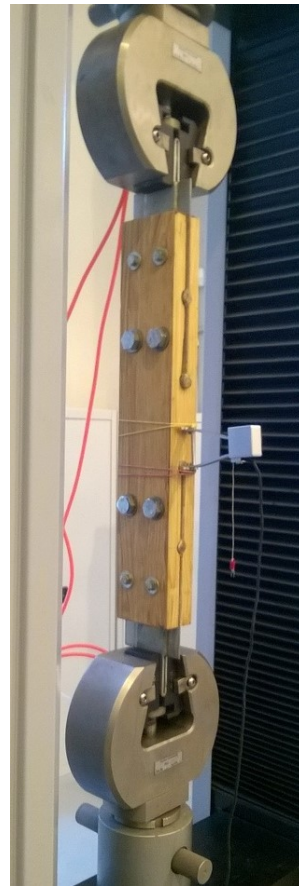

Fig. 3 Testing specimen described as Model 8 before assembly
Process of testing of 2 variations of connection is shown in Fig.4 a) and Fig. 4b).



a) Test specimen described as model 8



b) Test specimen described as model 9

Fig. 4. Process of testing 2 variations of studied timber connection

3. Results and Discussion

3.1. Numerical studies.

After conducting numerical simulations in Ansys mechanical following results were obtained. The range of load bearing capacity of a connection was from 55kN to 115kN. Stiffness of modeled timber joint expressed as a ratio of an applied force to displacement of steel plate, assuming deformation of steel plate negligible, was in range of 40 to 110 kN/mm. Models where bolts were utilized only as tightening elements demonstrated least stiffness and ultimate strength whereas connections with tightening bolts transferred shear forces showed the most stiffness and ultimate strength. Models with additional pre-stressing in tightening bolts have stiffness laying in between upper and lower bounds of a stiffness range.

Bearing areas A_{rc} for weld-in rods and A_{cb} for bolts in shear were obtained from models. Results of numerical simulations and variable parameters are shown in the Table 2

Table 2. Results and variable parameters of FEMA in ANSYS Mechanical

Model number	Bearing area of weld-in rods $A_{rc}(\text{cm}^2)$	Bearing area of bolts in shear $A_{cb}(\text{cm}^2)$	Pretension (kN)	Stiffness K(kN/mm)	Yield strength $N_y(\text{kN})$	Net Area of weaknesses $A_0(\text{cm}^2)$	Theoretical yield strength(kN)
1	34.72	-	-	42	53.6	10	51.6
2	34.72	24.1	-	93	95	10	88.3
3	43.9	-	-	41	70.35	12	64.7
4	34.72	-	20	45	53.6	10	51.6
5	34.72	36.15	-	110	95	10.8	112.0
6	34.72	18.07	-	87	85.72	10.8	77.3
7	-	36.15	-	82	72.9	10.8	86.8
8	61.4	-	-	40	72.9	16	72.7
9	61.4	27.1	-	95	95	16	115.5
10	34.72	-	32	61.2	65.2	10	51.6

Results of FEMA are presented in the compounded graph in fig.5. Stress-strain state of one of the model is presented on fig.6

Strength of a connection transferring tension force in general can be determined by several limit states:

- rapture of wood in weakened cross- section of timber member;
- failure of steel plate under the load;
- failure of bearing compressed areas under the weld-in rods
- shear failure of wood in area between 2 weld-in rods

- e) failure of bolts in shear (for connections of combined type) due to bearing failure of wood
- f) failure of bolts in shear
- g) displacements or slip of steel plate exceeding serviceability limit state

Strength of a timber connection is defined by minimal value of actual strength calculated for each limit state. Actual strength can be described as a function of several variable parameters:

$$[N] \leq N(A_{rc}, A_{cb}, f_{yt}, A_n, A_{nsp}, f_{ys}) / \gamma_c \quad (1)$$

where f_{yt} - yield strength of wood in tension for defined grade and species, A_n - net cross section of a timber member, A_{nsp} - net cross section of a steel plate, f_{ys} - yield strength of steel, γ_c - safety factor from 1.1 to 1.4.

For instance actual strength of a connection defined by failure mode c) should be determined as follows:

$$N = n * l * (d-t) * f_{yt} \quad (2)$$

where n - number of weld-in rods per one plate, l - width of a timber member, t - thickness of a steel plate.

Actual strength of a connection defined by failure mode d) should be determined as follows:

$$N = 2 * l * b * f_{sh} \quad (3)$$

f_{sh} - yield strength of wood in shear for defined grade and species

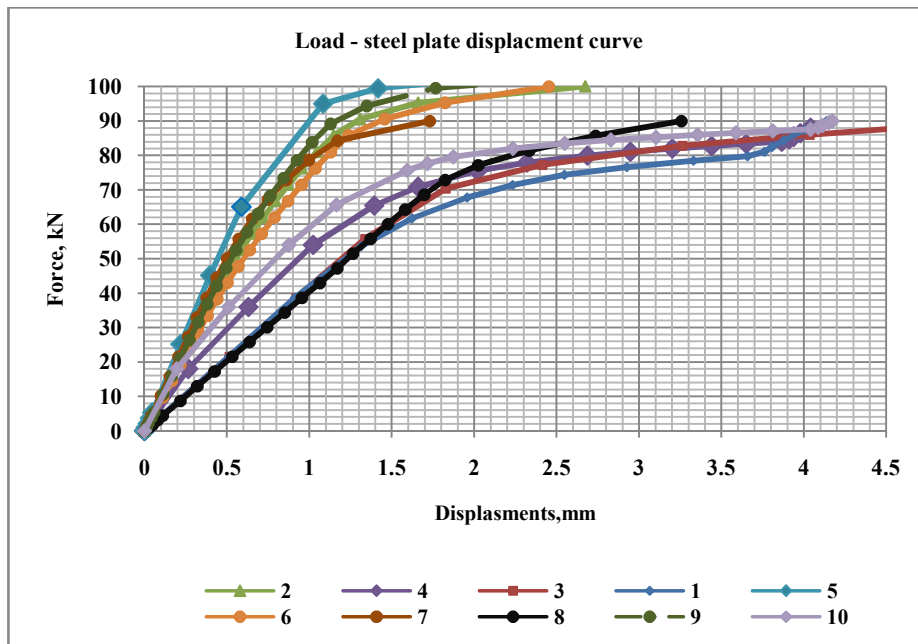
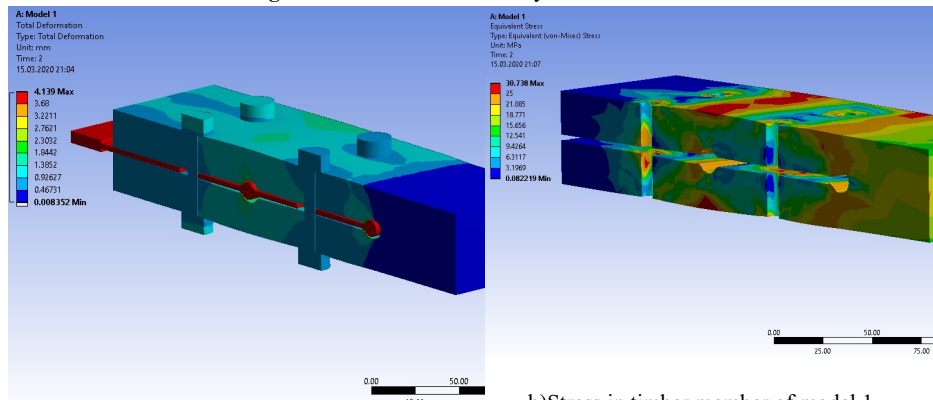

Fig.5. Results of FEMA in Ansys Mechanical.



a) Deformations in model 1

b) Stress in timber member of model 1

Fig.6. Stress-strain state of connection.

Several dependences were observed after FEMA in Ansys Mechanical. Load-displacement curves for reviewed models tended to group as following:

- models with tightening bolts transferring load as dowels complementary to weld-in rods in the steel plate (steeply inclined curves 7, 2, 6, 9, 5 Fig.5) ;
- models with tightening bolts working only as bounding elements of connection (slightly inclined curves 1, 3, 8 Fig.5)

- c) same as b) only with additional tightening pretension force from 20kN to 32 kN

For group b) increase in overall bearing area of weld-in rods (A_{cr}) leads to higher yield strength of connection but not linearly. Stiffness of connection described as load/displacement ratio (kN/mm) doesn't change with increased A_{cr} . For group a) increase in overall bearing area of tightening bolts transferring load as dowels (A_{cb}) has more effect on strength and stiffness than that of an A_{cr} . Also non linear load-slip dependence, like in [18] was observed

As a result of FEMA following equations were empirically deduced to optimize accuracy of calculations for c) and e) failure modes (without pretension configuration):

$$N \leq \left(\frac{37}{1+2.02e^{-0.12A_{cr}}} \left(1 - \frac{A_{cb}}{A_{cr}+A_{cb}} \right) + A_{cb} \right) f_{ytc} \quad (4)$$

Where f_{ytc} -yield strength of wood in compression for defined grade and species
 A_{cb} – overall bearing area of tightening bolts transferring load as dowels (cm²).
 A_{cr} – overall bearing area of weld-in rods (cm²)

3.2. Experiments.

After testing of specimens with parameters as in model 8 an 9 following failure modes were observed:

- a) Bearing failure of timber in areas of contact with weld-in rods with subsequent sliding of a steel plate to the point where tightening bolts start participate in force transfer i.e. all bolt-hole gaps in steel plate were closed (Model 8) ;
- b) Bearing failure of timber in areas of contact with weld-in rods following by rapture failure of timber in weakened area of cross-section (Model 9) like in [17]

Observed failure modes presented in fig. 7

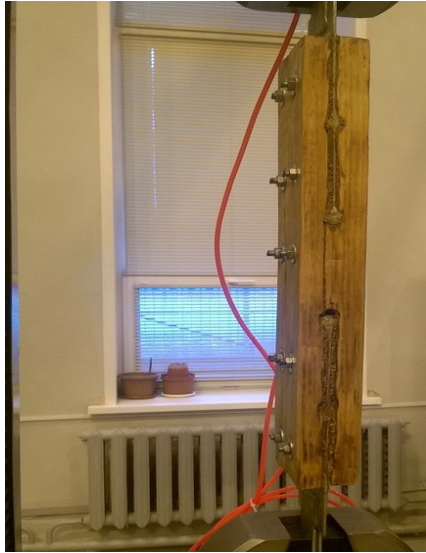

a) Failure mode of model 8 test specimen



b) Faillure mode of model 9 specimen

Fig.7. Failure modes of tested specimens

Load-displacement curves for described specimens obtained in testing machine are shown in fig. 8. It is worth mention that displacements in fig. 8 were measured for movable cross-head, therefore, contained slips of a steel plate inside grips. Also data in the graph accounts for double sided connection i.e. 2 steel plates. In order to exclude slips from measurements extensometer with one of its leg placed on steel plate and other on timber member was utilized. Load displacement curve with displacement of a steel plate is shown in fig. 9. Data for model 8 shown in fig.9 were erroneous due to failure of connection from other side of double sided specimen.

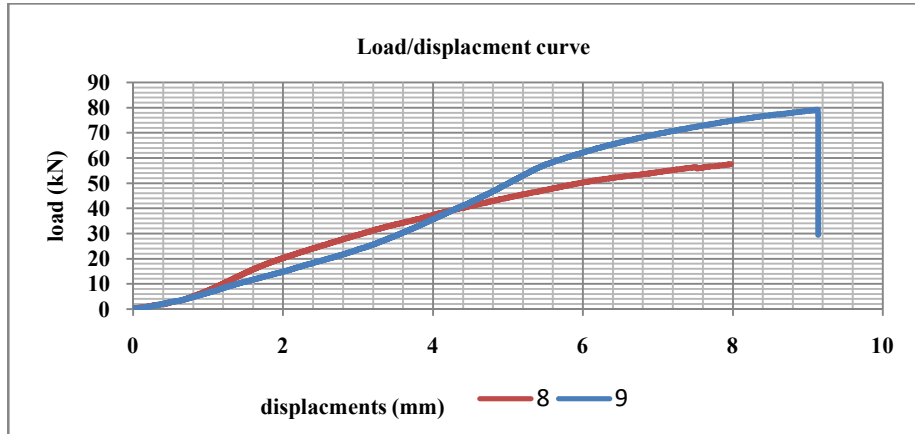

Fig. 8 Test results as load /displacement curve for 8 and 9 models

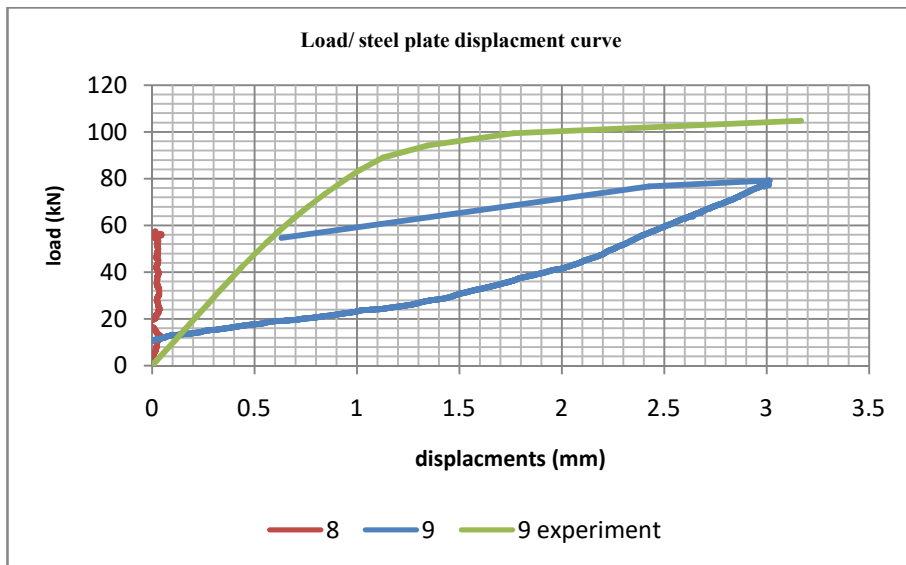

Fig. 9 Test results as load / steel plate displacement curve for 8 and 9 models

By comparing results of FEMA with experiment data following points can be made:

- There is substantial difference between stiffness obtained during experiment and FEMA in Ansys Mechanical, which possibly can be explained by imperfections in the experiment specimen comparatively

to a finite element model, such as uneven surface of a weld throat and gaps.

- Yield strength of connection is more in line with experiment data which confirms underlying hypothesis of choosing A_{rc} and A_{bc} as key parameters.

4. Conclusions

After conducting FEMA in Ansys Mechanical and experiment with timber connection following results were achieved:

- Calculation method was deduced for assessing approximate yield strength of studied type of timber connection;
- Testing methods were developed for this types of connections;
- Finite elements model with solving process in nonlinear settings were optimized for reasonable calculation time

In conclusion of this study in general following points can be made:

- Design solution of studied timber connection was rendered viable and can be, with proper further testing, utilized in real design projects with timber members in tension;
- Most high performing variants of timber connection are of a “combined” type, where tightening bolts transfer force as dowels complimentary to the weld-in rods;
- “combined” type of connection has yield strength 30% higher than of a initial type, where tightening bolts only bound timber and steel plate together without transferring any force;
- Quality of manufacturing affects strength of a connection substantially, therefore relevant techniques should be developed;
- Further studies can address question of how this connection transferring compressing force.

References

1. Padilla-Rivera, Alejandro & Blanchet, Pierre: Carbon footprint of pre-fabricated wood buildings. International symposium on sustainable design pp. 88-95. (2017).
2. Julie LysloSkullestad, Rolf AndréBohne, Jardar Lohne: High-rise Timber Buildings as a Climate Change Mitigation Measure. A Comparative LCA of Structural System Alternatives Energy Procedia Vol.96, Sep. 2016, Pages 112-123 (2016)

3. Gold S, Rubik F Consumer attitudes towards timber as a construction material and towards timber frame houses - selected findings of a representative survey among the German population. *Journal of Cleaner Production* 17(2):303-309 (2009).
4. Franke S, Magnière N: Discussion of testing and evaluation methods for the embedment behavior of connections. INTER Meeting 47, Paper 47-7-1, pp. 93-102, Bath, UK (2014).
5. Gattesco N: Strength and local deformability of wood beneath bolted connectors. *Journal of Structural Engineering* 124(2), pp. 195-202 (1998)
6. Biger JP, Bocquet JF, Racher P: Testing and designing the joints for the pavilion of Utopia. World Conference on Timber Engineering, Paper 4.3.3. Whistler, Canada. (2000)
7. Hong JP: Three-dimensional nonlinear finite element model for single and multiple dowel-type wood connections. PhD thesis, University of British Columbia. (2007)
8. I. I. Lisitskii, V. I. Zhadanov: Joint connections on the basis of the pasted flat cores in truss structures. *Vestnik of Volga State University of Technology. Series: Materials. Structures. Technology.* pp 59-68 (2019)
9. Franke S, Quenneville P: Bolted and dowelled connections in Radiata pine and laminated veneer lumber using the European Yield Model. *Australian Journal of Structural Engineering* 12(1): pp.13-27. (2011)
10. Jorissen A: Double shear timber connections with dowel type fasteners. PhD thesis, Delft University of Technology. (1998)
11. Dorn M: Investigations on the serviceability limit state of dowel-type timber connections. PhD thesis, Vienna University of Technology. (2012)
12. Sandhaas C: Mechanical behaviour of timber joints with slotted-in steel plates. PhD thesis, Delft University of Technology. (2012)
13. Hochreiner G, Bader TK, Schweigler M, Eberhardsteiner J: Structural behaviour and design of dowel groups Experimental and numerical identification of stress states and failure mechanisms of the surrounding timber matrix. *Engineering Structures* 131: pp. 421-437 (2017)
14. Sawata K, Kawamura H, Takanashi R, Ohashi Y, Sasaki Y : Effects of arrangement of steel plates on dowel type cross laminated timber joints with two slotted-in steel plates subjected to lateral force. World Conference on Timber Engineering, Vienna, Austria. pp. 1556-1563 (2016)
15. Gecys T, Daniunas A, Bader TK, Wagner L, Eberhardsteiner J: 3D finite element analysis and experimental investigations of a new type of timber beam-to-beam connection. *Engineering Structures* 86, pp.134-145. (2015)
16. Iraola B, Cabrero JM, Gil B: Pressure-overclosure law for the simulation of contact in spruce joints. World Conference on Timber Engineering, At Vienna pp. 2019 -2027 (2016)
17. Cabrero JM, Yurrita M: Performance assessment of existing models to predict brittle failure modes of steel-to-timber connections loaded parallel-to-grain with dowel-type fasteners. *Engineering Structures* 171, pp. 895-910 (2018)
18. Hirai T: Non-linear load-slip relationship of bolted wood-joints with steel side members – II – Application of the generalized theory of beam on an elastic foundation. *Makusu Gakkaishi* 29(12):pp. 839-844. (1983)
19. Resch E, Kaliske M.: Numerical analysis and design of double-shear dowel-type connections of wood. *Engineering Structures* 41: pp. 234–241.(2012)
20. Diaz JJ, Nieto PJ, Luengas AL, Dominguez FJS, Hernandez JD.: Non-linear numerical analysis of plywood board timber connections by DOE-FEM and full-scale experimental validation. *Engineering Structures* 49, 49:pp.76–90 (2013)
21. O’Loinsigh C, Oudjene M, Shotton E, Pizzi A, Fanning P.: Mechanical behaviour and 3D stress analysis of multi-layered wooden beams made with welded-through wood dowels. *Composite Structures* 94, pp.313–21.(2012)